CONTENTS

1	PRODUCT OVERVIEW	3
2	PRODUCT STRUCTURE	4
3	HOST CONFIGURATION	5
4	PRINTER CONFIGURATION (OPTIONAL)	6
5	POWER ON/OFF	6
	1) Power on	6
	2) Power off	7
6	VEHICLE DIAGNOSTIC PREPARATION	7
7	INTRODUCTION OF EACH FUNCTION MENU	10
8	DIAGNOSTIC FUNCTION	13
9	DPF REGENERATION	17
10	PIN DETECT	18
11	DATA MANAGEMENT	19
12	DIAGNOSTIC SOFTWARE UPGRADE	19
13	SETTINGS	20
	13.1 Wi-Fi Connection	20
	13.2 Brightness	21
	13.3 Volumes.....	21
	13.4 User Information and Activation.....	22
	1) Activation	22
	2) User Info	22
	13.5 Storage.....	23

13.6 General.....	23
1) <i>Language</i>	23
2) <i>Unit</i>	24
3) <i>Date&Time</i>	24
4) <i>About</i>	25
5) <i>Reset</i>	25
14 PRINTER INTRODUCTION	26
1) <i>Printer combination and split</i>	26
2) <i>Printer loading and changing paper</i>	27
3) <i>Printer self-test function</i>	28
15 FAQ(FREQUENTLY ASKED QUESTIONS)	29

1 Product Overview

ANCEL HD series products are commercial vehicle diagnostic tools based on special Android tablet.

This product integrates commercial vehicle OBD standard diagnostic protocols, including SAE J1939, SAE J1708, SAE J1850 PWM, SAE J1850 VPW, ISO 14230-4, ISO 9141-2, ISO 15765-4 and ISO 27145-4. The commercial vehicles are classified according to the vehicle type information, and the operation interface is very clear, which makes it convenient for users to diagnose commercial vehicles.

There's an optional printer module available to have diagnosis data and report printed. At the same time, the product supports online upgrade of diagnostic program and diagnostic data.

2 Product Structure

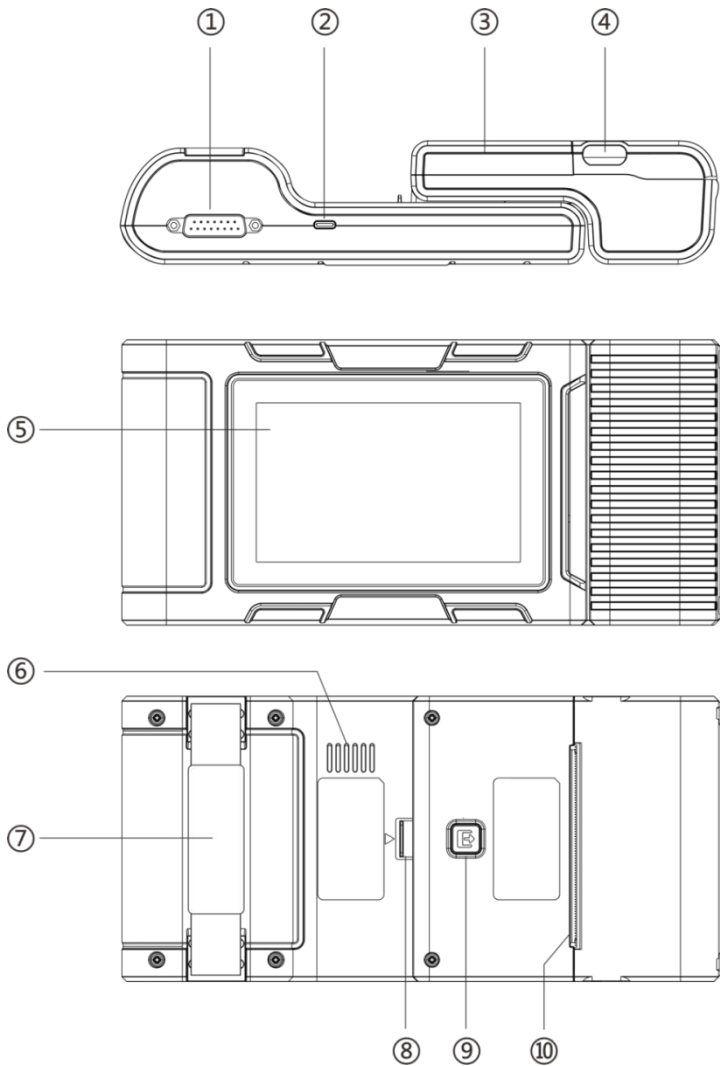

Serial No.	Name	Function Description
①	Main Testing Cable	Connection interface connects vehicle communication cable during vehicle diagnosis
②	USB Port	Used to connect to an external computer
③	Print	Used to print diagnostic reports and results
④	Paper bin cover	After opening, you can install and replace the printing paper
⑤	Touch screen	Display content and touch operation area
⑥	Speaker	Device sound output
⑦	Auxiliary bandage	Auxiliary for hand holding
⑧	Separation switch	Host and printer separation switch
⑨	Test key	Printer self-test and paper feed button
⑩	Paper outlet	Printer paper outlet

3 Host Configuration

CPU	Quad-Core ARM Cortex-A7
RAM	1GB
Flash	8GB
Display	5 inches LCD, resolution ratio 800*480

TP touch screen	Capacitive screen
WIFI	802.11b/g/n 2.4GHz
Horn	Support
USB interface	Type C interface
Diagnose interface	DB15 interface
Operating voltage	DC 10V~24V/3A
Operating temperature	-20°C~ 60°C
Storage temperature	-30°C~ 70°C

4 Printer Configuration (Optional)

Printer	80mm thermal printer
Print speed	60mm/s
Effective print width	72mm
Print resolution	203dpi 1mm=8dots
Print paper specifications	80mm*30mm

5 Power On/Off

1) Power on

The device can be powered on in the following ways:

Vehicle power on: plug one end of the main diagnostic test line into the DB-15 interface of the device, and the other end into the diagnostic interface of the vehicle, and the device will

automatically start up. If it doesn't start up, it may be that there is no power supply for the vehicle diagnostic seat, and the device can be powered by the cigarette lighter or battery clamp.

Power on the power adapter: plug one end of the main diagnostic test line into the DB-15 interface of the device, connect the power adapter, and the device will start automatically.

Note: the voltage of the power supply should be within the scope of application of the product equipment. If it is beyond the scope, the product may be damaged.

2) Power off

Before power off, please stop all diagnostic items and return back to the main interface.

Pull out the diagnostic main test line from the diagnostic interface of the vehicle. If the device is not equipped with battery, the device will shut down automatically after disconnecting the main test line from the diagnostic interface of the vehicle.

6 Vehicle Diagnostic Preparation

The diagnostic program establishes data connection through the vehicle electronic control system connected with the equipment, which can read the vehicle diagnostic information, view the data flow, and perform action test and other functions. For details of the functions, please refer to the model which you purchased.

To establish good communication between the diagnostic program and the vehicle, the following operations need to be

performed:

- 1) Turn off the ignition;
- 2) Find the diagnostic interface of the vehicle: it is usually located on the driver side; If the diagnostic interface is not found, please refer to the vehicle maintenance manual.
- 3) Insert one end of the diagnostic main test line into the device DB-15 connector and tighten the retaining screws. The other end is connected to the vehicle's diagnostic interface.

Note: Before the equipment is connected to the vehicle, it is necessary to judge whether the diagnostic seat of the vehicle is a standard OBD-II interface or a non-standard OBD-II interface.

- The vehicle compatible with OBD-II management system only needs to use the integrated main test line OBD connector to connect with the vehicle diagnosis seat and provide power;
- For vehicles that are not compatible with the OBD-II management system, the corresponding connector should be selected; Some vehicles need to be powered by other vehicle power sources.

The following is an operation description of these two connection modes.

1) Connection of standard OBD-II interface

The vehicle connected with standard OBD-II interface only needs to use the integrated main test line OBD connector, and no other connectors are needed, as shown in the figure:

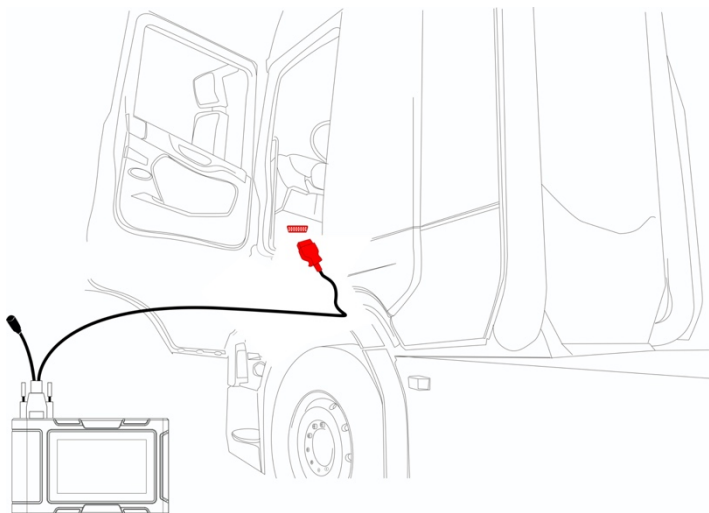

2) Connection of non OBD-II interface

Vehicles with non OBD-II interface need to connect the main test line with the corresponding special connector, as shown in the figure:

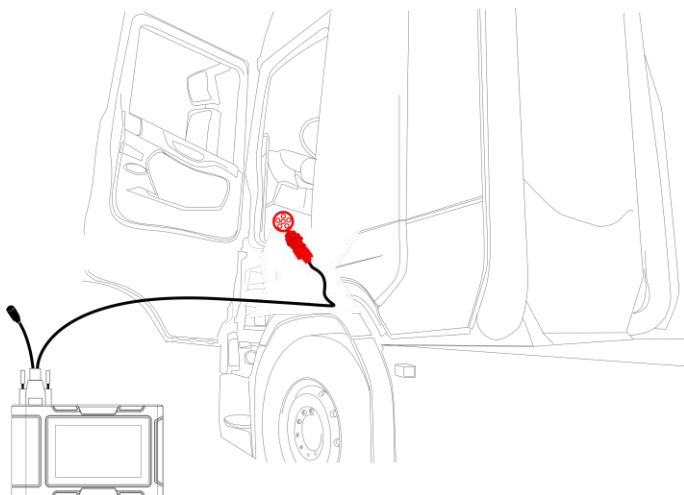





Note: at this time, the equipment is powered by the vehicle diagnosis seat, and the equipment starts automatically. If not, it may be that the vehicle diagnosis seat has no power supply, and the equipment can be powered by the cigarette lighter or battery clip.









7 Introduction of Each Function Menu

After the system is started, the main menu of function will be entered. The main menu of each version of model will be slightly different. Please refer to the display of the model you purchased.

- 1) Toolbar (see Table 1)
- 2) Function main menu (see Table 2)

Table 1: Toolbar

Icon	Function name	Function description
	Refresh	Refresh upgrade menu
	Home	Return to the main interface of the system
	Screenshot	Capture current screen picture
	Test report	Used to save test data during diagnosis (can be viewed in data management menu)

Icon	Function name	Function description
	Feedback	Used to report the problem to the company's service system (need to connect to the network) when the system cannot be accessed during the diagnosis process
	Print	Used to print test results or test reports. The printer is optional
	Edit	Used to edit files, lock, unlock or delete files
	Added	Used to add feedback information
	WIFI	WIFI connection network
	Brightness	Used to adjust the brightness of the device screen
	Volume	Used to adjust the volume of the device
	User info	Used to view device status and user information
	Data cleaning	Used to remove useless data from the device









	General	Used to set device language, unit and time, view device information and restore factory settings
---	---------	--

Table 2: Function main menu

Icon	Function name	Function description
	Diesel OBD	Diagnostic procedure: Diesel OBD, see section 5 for details
	OBD-II	Diagnostic procedure: OBD-II, see section 5 for details
	Engine diagnosis	The diagnosis menu of each engine will be slightly different. Please refer to the model you purchased
	DPF	DPF regeneration
	Tools	(Pin Detect)For the measurement of pin voltage of diagnostic interface, see section 6 for details
	Data management	For browsing and managing saved data files, see section 7 for details
	Update	For online upgrade of system software and vehicle software, see section 8 for details
	Settings	Set and view system information, see section 9 for details

8 Diagnostic Function

1) Take **【Diesel OBD】** as an example;

Click **【DIESEL OBD】** menu enter the diagnosis interface.



2) Select connector according to the specific situation, such as **【Diesel6&9PIN】** ;

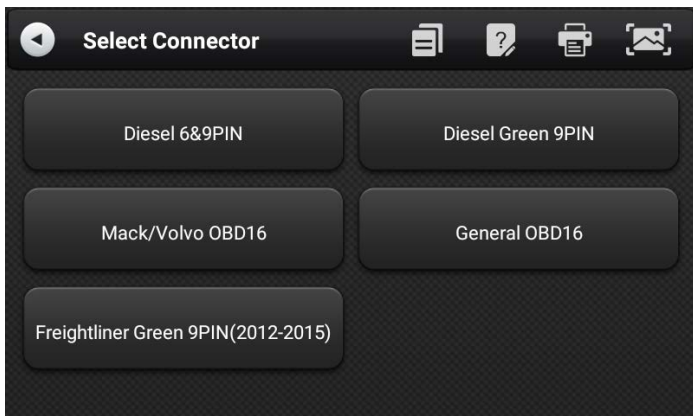

3) Select the required diagnostic method, such as **【Standard protocol(Fast Scan)】** ;



4) Click **【Start test】**

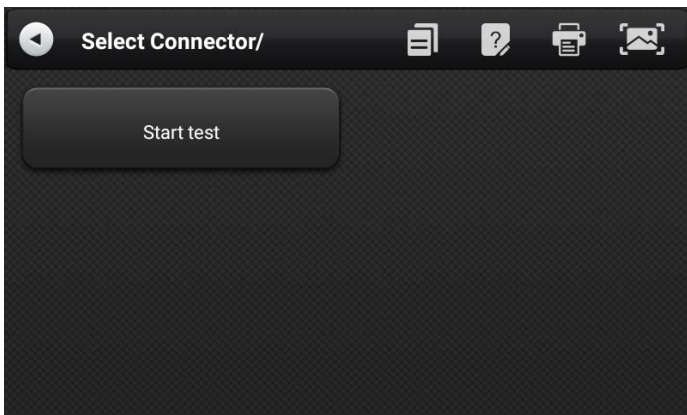

5) Select **【(J1939) Engine】** ;

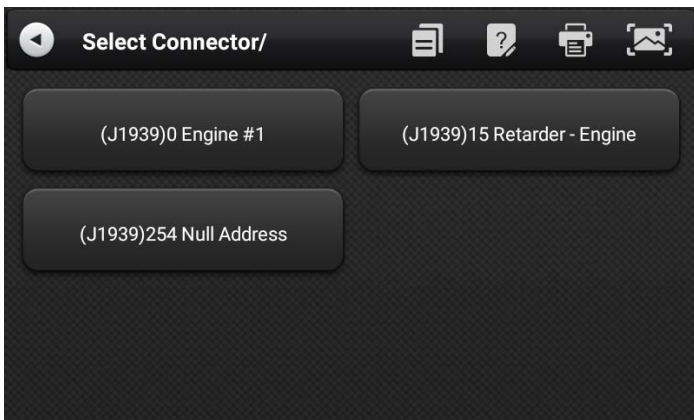

6) Enter **【Diagnosis home page】** ;

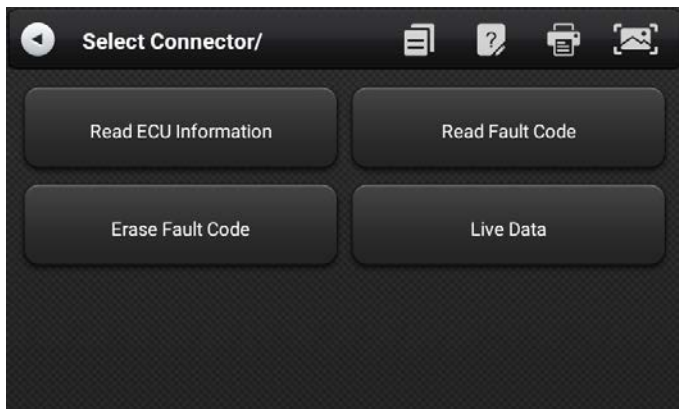

The main diagnostic interface usually includes the following options:

ECU Information: Read and display the control system module information detected from ECU.

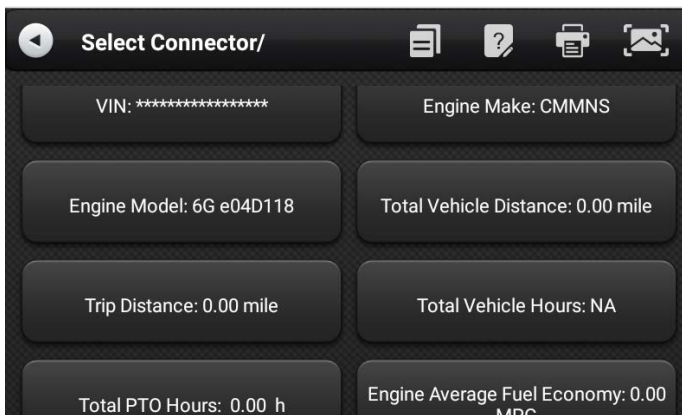

Read Fault Code: Read the fault code information retrieved from the vehicle system module.

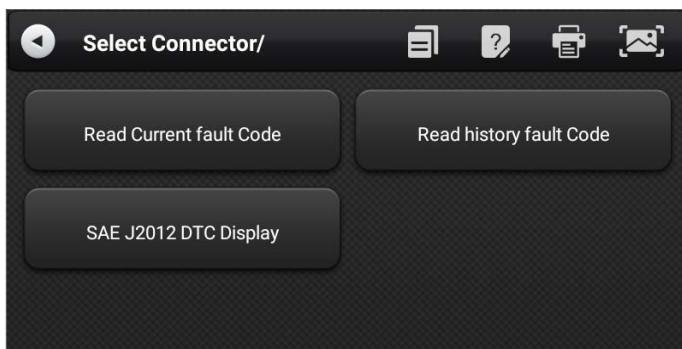

Erase Fault Code: Clear the fault code and freeze frame data retrieved from the vehicle system module

Live Data: Read and display the real-time operation parameters of the current system module

ID	Name	Current values
1	ASR Engine Control Active	NA
2	ASR Brake Control Active	NA
3	Anti-Lock Braking (ABS) Active	NA
4	EBS Brake Switch	NA
5	Brake Pedal Position	0 %
6	ABS Off-road Switch	NA

Graphic Compare Save

ID	Name	Current values
327	Fuel Level 1	0 %
328	Engine Fuel Filter Differential Pressure	0 psi
329	Engine Oil Filter Differential Pressure	0 psi
330	Cargo Ambient Temperature	32 °F
331	Fuel Level 2	0 %
332	Water In Fuel Indicator 1	NA
333	Operator Shift Prompt	NA

Graphic Compare Save

9 DPF Regeneration

Select **【DPF】** in main menu, the screen will display the vehicle model list and then operate according to the screen prompt.

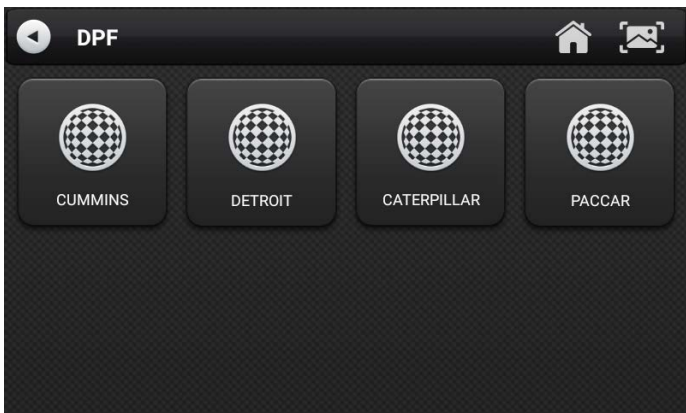

10 Pin Detect

This function mainly measures the voltage of 16 PIN of OBD diagnostic interface, and judges the pin position of K- line and CAN line.

After connecting the OBD interface of vehicle, click the main interface **【Tools】** to select pin detection. The program automatically measures the 16pin voltage of OBD diagnosis interface, and judges the pin position of K-line and can line, as shown in the figure below:



11 Data Management

【Data Management】 The function is used to save and view test reports, screenshots and problem feedback files. Most of the files are generated by executing the toolbar operation of the vehicle diagnosis interface.

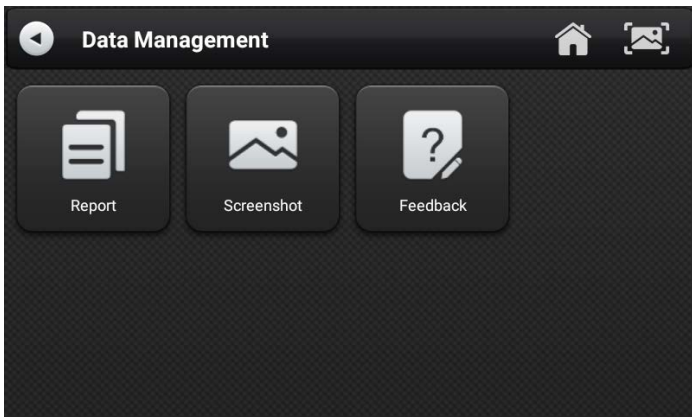

12 Diagnostic Software Upgrade

By connecting the device to the wireless network, the diagnostic software can be upgraded and the product function can be improved in time. Open 【Update】 in the function main menu, and the system will automatically search for the latest update program, as shown in the figure below. Click 【Update】 to upgrade the model and other applications to the latest version.

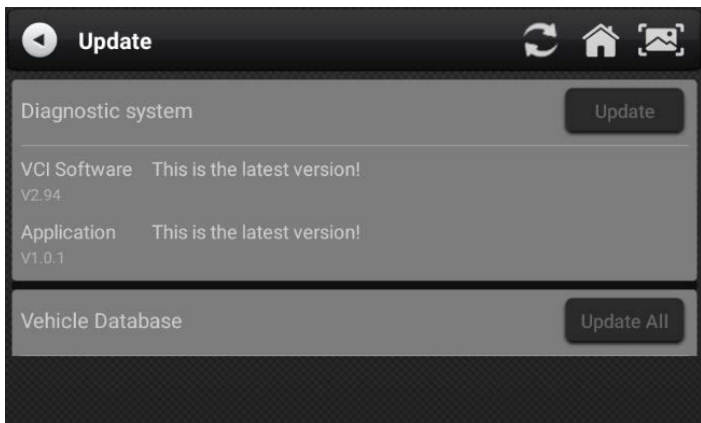

13 Settings

Select **【Settings】** from the main menu to open the setting interface, where you can adjust the following system settings.

13.1 Wi-Fi Connection

The device supports wireless network connection for diagnosis software upgrade and problem feedback.

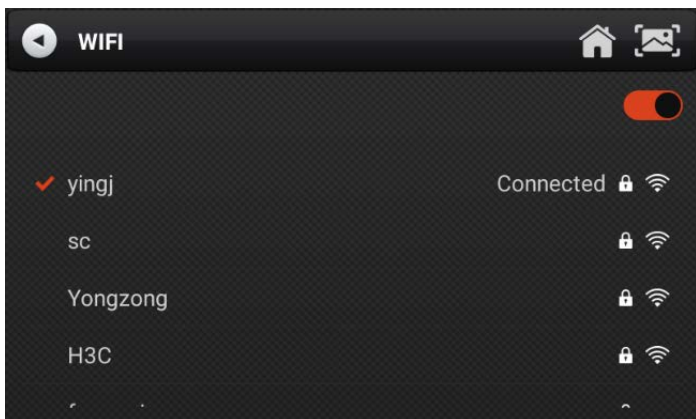

13.2 Brightness

The device supports screen brightness setting, please adjust it according to your adaptive brightness.



13.3 Volumes

The device supports volume adjustment.

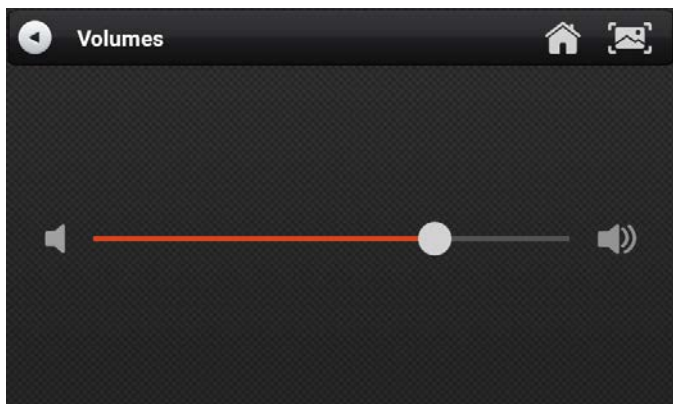

13.4 User Information and Activation

1) Activation

The products are not activated when they leave the factory.

Connect the network to enter the setting, and click

【Activation】 to activate the machine.

Note: Please ensure that the device is connected to an effective Wi-Fi network before performing the activation operation.

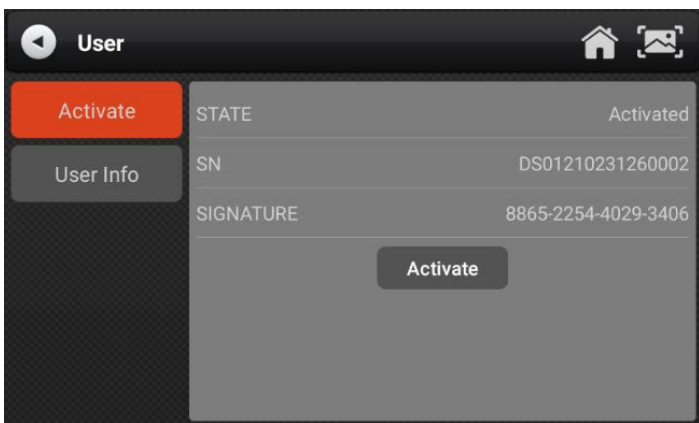

2) User Info

Set your personal information: name, telephone, email, address, etc.

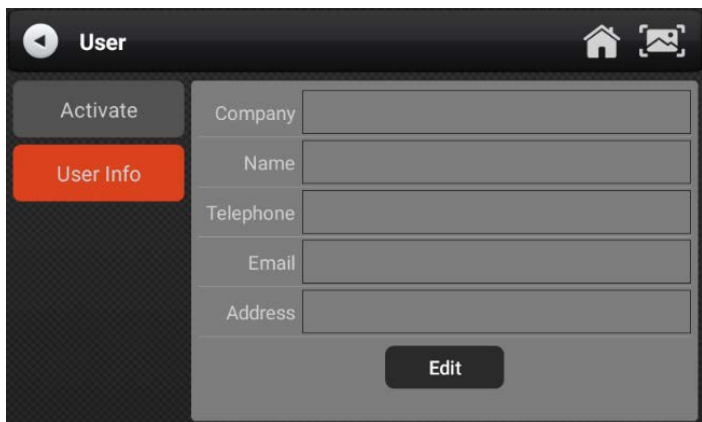

13.5 Storage

Cleaning up useless data with one click, freeing up more space and cleaning up regularly will help the system run more stably.

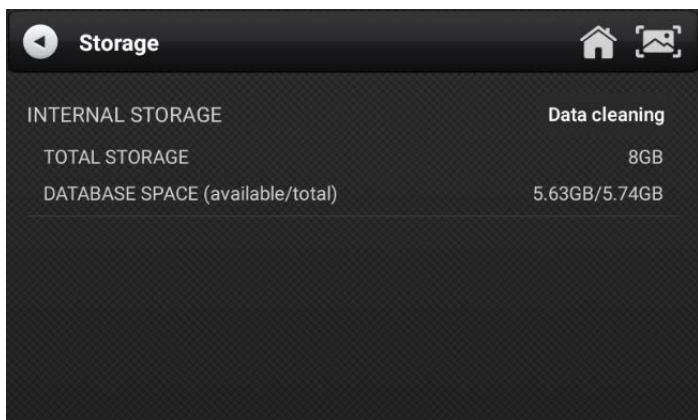

13.6 General

- 1) Language

Please select settings based on the language you support for the model you purchased.

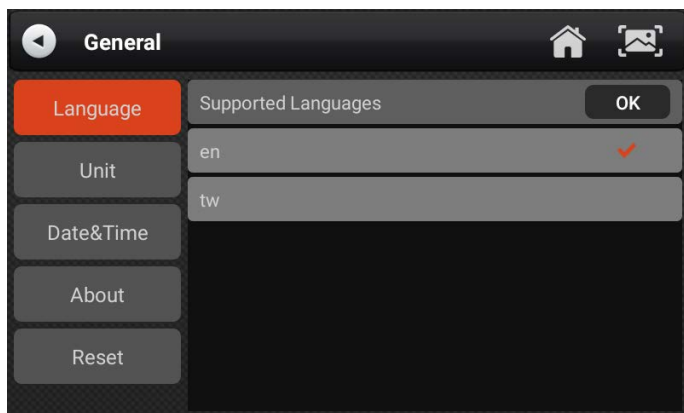

2) Unit

This option can set the data flow unit in the diagnostic equipment software. Please select metric system or English system as required.

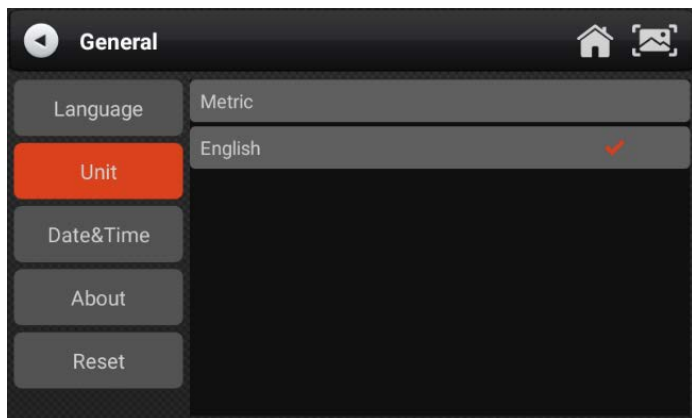

3) Date&Time

This option can set the date / time of the device. The default is automatic network synchronization update, or it can be set manually.

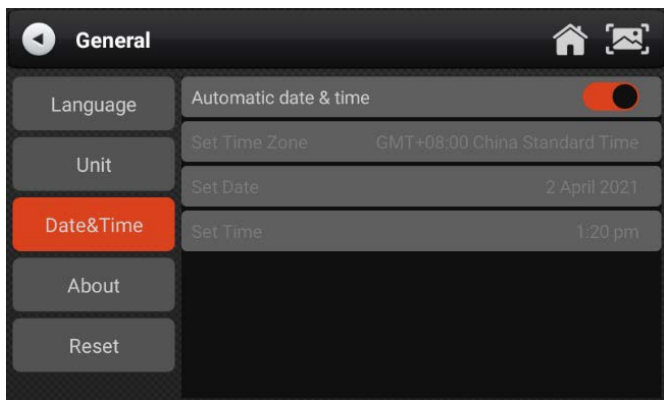

4) About

This option is used to look up the device model, version, serial number, etc.

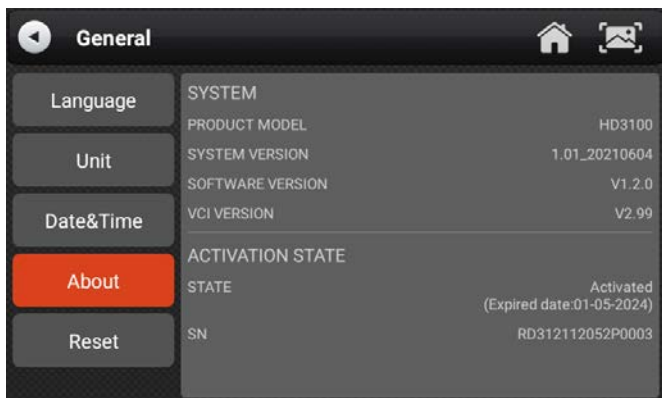

5) Reset

This option can restore the original settings of the device, which will delete all the data stored in the device, including the activation information and model data. You need to re-connect the network to activate and download the model data package.

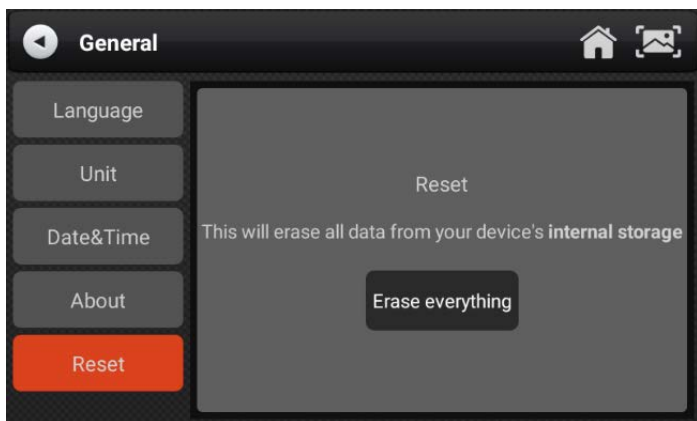

14 Printer Introduction

- 1) Printer combination and split

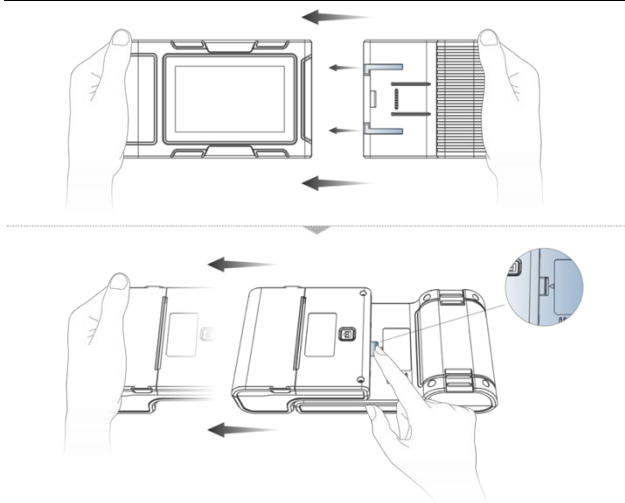

1. Hold the printer in your hand, aim at the lead-in slot on the back of the main unit, push it in slightly, and you will hear a “click” voice, which means the main unit and the printer has already connected together.
 2. After pressing the separation switch, hold the printer in your hand and gently pull it out. The printer will be separated from the host.
- 2) Printer loading and changing paper

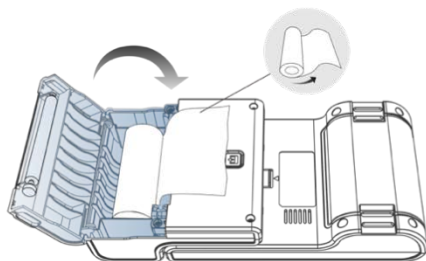
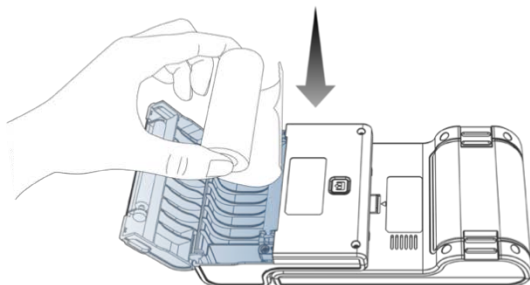
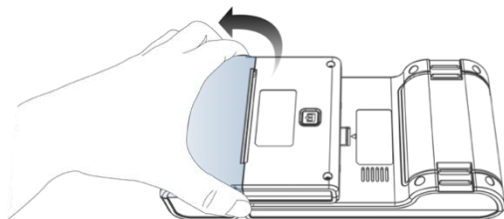

1. Hold the position of the printer paper bin cover with your fingers and open the cover up;
 2. Put the printing paper into the paper bin according to the diagram. Pay attention to the direction of the paper. If the installation is reversed, the printing will be blank;
 3. Just close the paper bin cover.
- 3) Printer self-test function

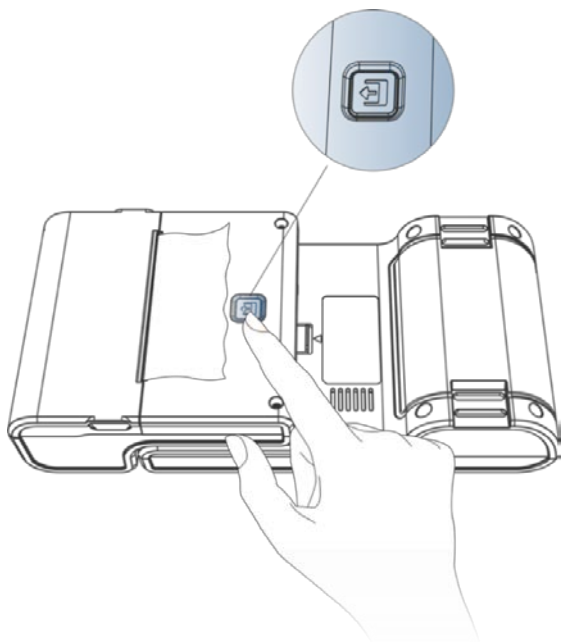

1. When the machine is turned on, press the printer test key briefly, and the printer will automatically print out a piece of blank paper.
2. In the case of power on, long press the printer test key for three seconds, the printer will automatically print a section of self-test content, indicating that the printer function is normal.

15 FAQ(Frequently Asked Questions)

Here are some frequently asked questions and answers about the HD3400.

Question: I cannot activate and register the tool.

Answer: There is no need to register the machine. If your activation was failed, please kindly check your network.

Question: What does the Simulate and DEMO menus mean?

Answer: Simulate and DEMO are both DEMO menus, not diagnosis function menus. The information in these menus was collected according to the actual vehicle diagnosis in the past, just for better understanding of product functions for users.

Question: Will it work on new (2018) freight liner with the new green connector?

Answer: Yes. The HD3400 machine has already included new green 9pin connector.

Question: I can't diagnose my vehicle with the tool. It shows "ECU no response".

Answer: Please do a voltage test via [pin detect]. If the voltage is abnormal, please check the hardware first.

Statement

This equipment has been tested and found to comply with the limits for a Class B digital device, pursuant to Part 15 of the FCC Rules. These limits are designed to provide reasonable protection against harmful interference in a residential installation. This equipment generates uses and can radiate radio frequency energy and, if not installed and used in accordance with the instructions, may cause harmful interference to radio communications. However, there is no guarantee that interference will not occur in a particular installation. If this equipment does cause harmful interference to radio or television reception, which can be determined by turning the equipment off and on, the user is encouraged to try to correct the interference by one or more of the following measures:

- Reorient or relocate the receiving antenna.
- Increase the separation between the equipment and receiver.
- Connect the equipment into an outlet on a circuit different from that to which the receiver is connected.
- Consult the dealer or an experienced radio/TV technician for help.

Changes or modifications not expressly approved by the party responsible for compliance could void the user's authority to operate the equipment.

This device complies with part 15 of the FCC Rules. Operation is subject to the following two conditions: (1) This device may not cause harmful interference, and (2) this device must accept any interference received, including interference that may cause undesired operation.

Certification

This product has been inspected and certified to meet the company's quality standards.

Product name	Truck Scanner
Product serial number	
Date of production	
Inspector	

Warranty card

Product name	Truck Scanner
Product serial number	
Purchase date	

Company name: _____

User address: _____

Contact person: _____

Contact number: _____